

Dimensiones Generales FAC

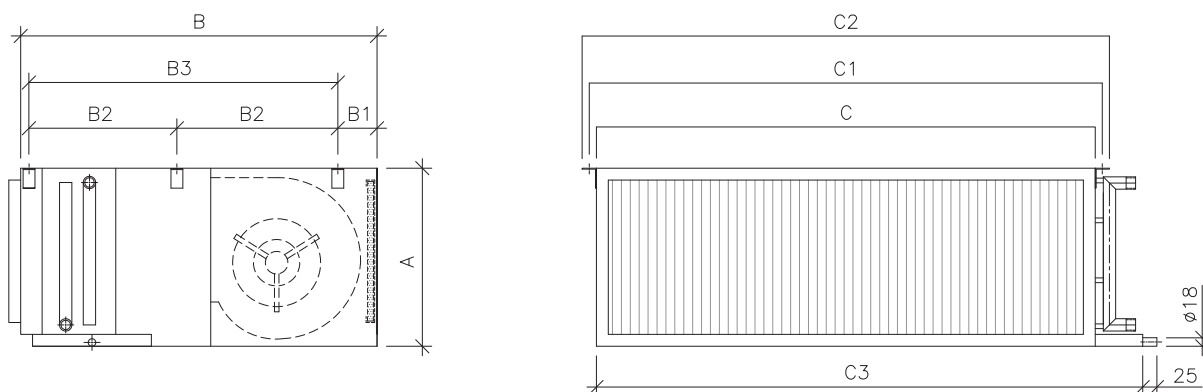

TAMAÑOS	A	B	C	B1	B2	B3	C1	C2	C3	PESO (Kg)
FAC-11	375	750	600	82,5	-	650	630	660	700	46
FAC-21	375	750	750	82,5	-	650	780	810	850	54
FAC-31	375	750	1050	82,5	-	650	1080	1110	1150	69
FAC-41	375	750	1350	82,5	-	650	1380	1410	1500	89
FAC-51	425	850	1550	82,5	375	-	1580	1610	1700	124

• Cotas en mm

DIMENSIONES FAC OPCIONALES

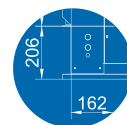

EMBOCADURA ASPIRACION Y ACCESO
LATERAL O INFERIOR FILTRO

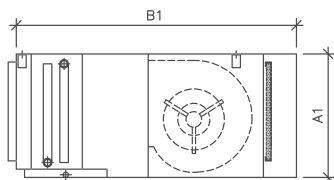

MODULO BATERÍA ELECTRICA
EN IMPULSION

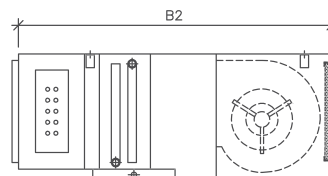

BANDEJA SUPLETORIA

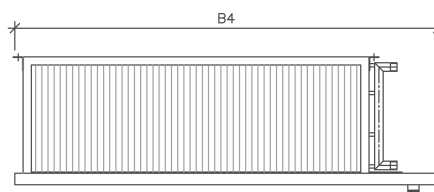
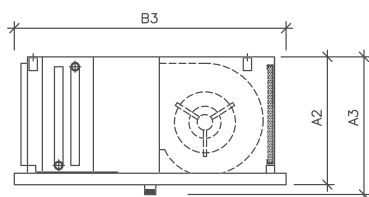

PLENUM DE IMPULSION Y/O MEZCLA

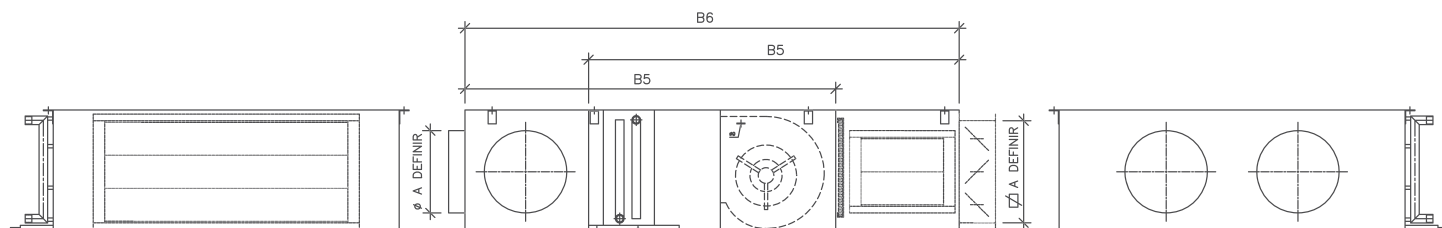

PLENUM DE SILENCIADOR EN IMPULSION
Y/O ASPIRACION

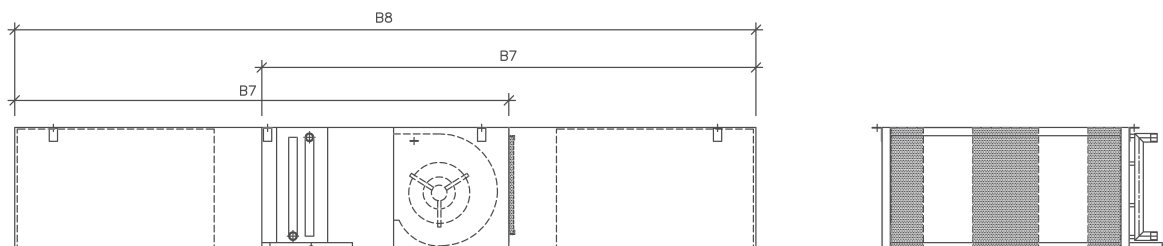

TAMAÑOS	A1	A2	A3	B1	B2	B3	B4	B5	B6	B7	B8
FAC-11	375	400	430	850	950	825	835	1125	1500	1500	2250
FAC-21	375	400	430	850	950	825	985	1125	1500	1500	2250
FAC-31	375	400	430	850	950	825	1285	1125	1500	1500	2250
FAC-41	375	400	430	850	950	825	1585	1125	1500	1500	2250
FAC-51	425	450	480	950	1050	925	1785	1275	1700	1600	2350

• Cotas en mm